

SKIRTING BOARDS





INVESTING IN FUTURE

Innovation, quality and know-how – since 1994 we've been investing in knowledge, technology and our machinery park. Over 20 years we create and improve our product portfolio. We aim to become market LEADER wherever we are present.

We provide solutions for the most demanding floor users. We share experience and set trends.

We are the FLOOR EXPERT.





CHECK OUR NEW SKIRTING BOARDS!



➔ D-ONE



➔ MACK





**UNIVERSAL SOLUTION
FOR LVT**

 11 | D-ONE SKIRTING BOARDS **NEW**

**WHITE DESIGN
FOR ALL FLOOR COVERINGS**

 15 | VEGA SKIRTING BOARDS

 18 | DORA SKIRTING BOARDS

 21 | PAINT-IT SKIRTING BOARDS

 24 | DIAMOND SKIRTING BOARDS

**WOOD DESIGN
FOR ALL FLOOR COVERINGS**

 27 | INTEGRA SKIRTING BOARDS

 30 | FADO SKIRTING BOARDS

 33 | INDO SKIRTING BOARDS

 37 | LARS SKIRTING BOARDS

 40 | MACK SKIRTING BOARDS **NEW**

 43 | LM 60 SKIRTING BOARDS

 47 | LM 55 SKIRTING BOARDS

**OTHERS SYSTEMS
FOR CERAMIC AND CARPET**

 52 | LATIKA SKIRTING BOARDS

 55 | TSL - SKIRTING BOARDS

 57 | UNIVERSAL PROFILES

DESIGN IS IN THE **DETAIL**

Arbiton is a well-known brand specialized in technologically advanced floor accessories.

Our floor system is designed from scratch in every detail.

Because we care about every detail.
We are the FLOOR EXPERT.



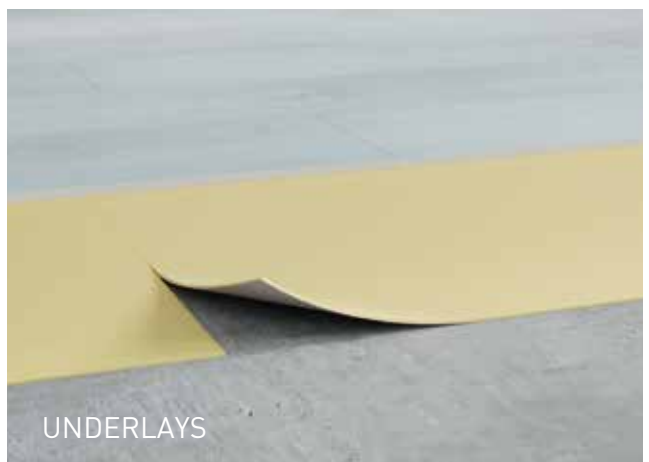

WHY ARBITON SKIRTING BOARDS?



→ RICH COLOUR PALETTE

Designs of Arbiton skirting boards are adjusted to the current market trends on regular basis. Use of the innovative Printing technology, distinguished by high resolution printing is the guarantee of the highest quality of an image and enables ideal matching of the board and the floor.

Decora's technologists have also developed original printing technology – Wood Effect in HD quality – which thanks to the high level of image details allows reproduction of natural wood.

→ COMPREHENSIVE OFFER

Arbiton offers skirting boards with numerous functions and assembly methods, manufactured from various materials ranging from PVC, Videlit, through MDF in different sizes and shapes, from classic to modern ones, with wide range of accessories.

→ PRODUCT AVAILABILITY

The skirting boards are available in the best construction and home improvement retail stores, as well as DIY stores across Europe. The use of comprehensive exposition system, with clear communication of values, allows Customers to find a product on their own and to recognize its benefits.

→ QUALITY GUARANTEE

Many years of experience and continuous improvement of manufacturing and logistic processes make Decora's products extremely durable which allows for a long-term use. The quality is confirmed with many consumer prizes and assembly workers' recognition.

→ ECOLOGY AND SAFETY

Products made of PVC and Videlit are safe for the users, perfectly adhere to the finished surface and are ecologically clean.

**100% WATERPROOF**

Clean your floor without any risk – non-deforming, water resistant board!

**IMPACT RESISTANT**

Highest resistance and stability

**KEEP IT WHITE OR PAINT IT**

The board which can be painted. Possibility of fully matching the board colours to the walls of the room

**GLOSSY SURFACE**

Lacquered skirting board

**WOOD EFFECT**

The ideal colour and design match, 100% accurate representation of wooden colors

**WOOD STRUCTURE**

Structure embossed on the surface, perfectly imitating the real wood

**FLEXIBLE**

Flexible adaptation to uneven walls

**EASY WALL RENOVATION**

Possibility of unfixing skirtings in order to paint or hide TV or audio cable (max 230V)

**4 WAY SYSTEM**

Solid, fast, simple installation and deinstallation, for any type of wall

**EASY INSTALLATION**

Wide installation channel provides an easy access for a drill or screwdriver. It makes installation quicker and easier

**ALWAYS CLEAN SURFACE**

Extremely smooth surface without micropores is a perfect barrier for dirt and dust

**CLICK OR GLUE**

Instal the skirting in two ways: glue skirting directly to the wall, or clip - strip easily and remove at any time.

**MODERN DESIGN**

Unique shape was created for a modern interiors and its simplicity is an answer even for the most demanding

**ECO FRIENDLY**

The board made of environmentally friendly material

**VIDELIT ECO FRIENDLY**

The board made of environmentally friendly material

**MDF**

Skirting board made from MDF covered with coated paper which increases durability. It's not necessary to paint the skirting board before the first installation

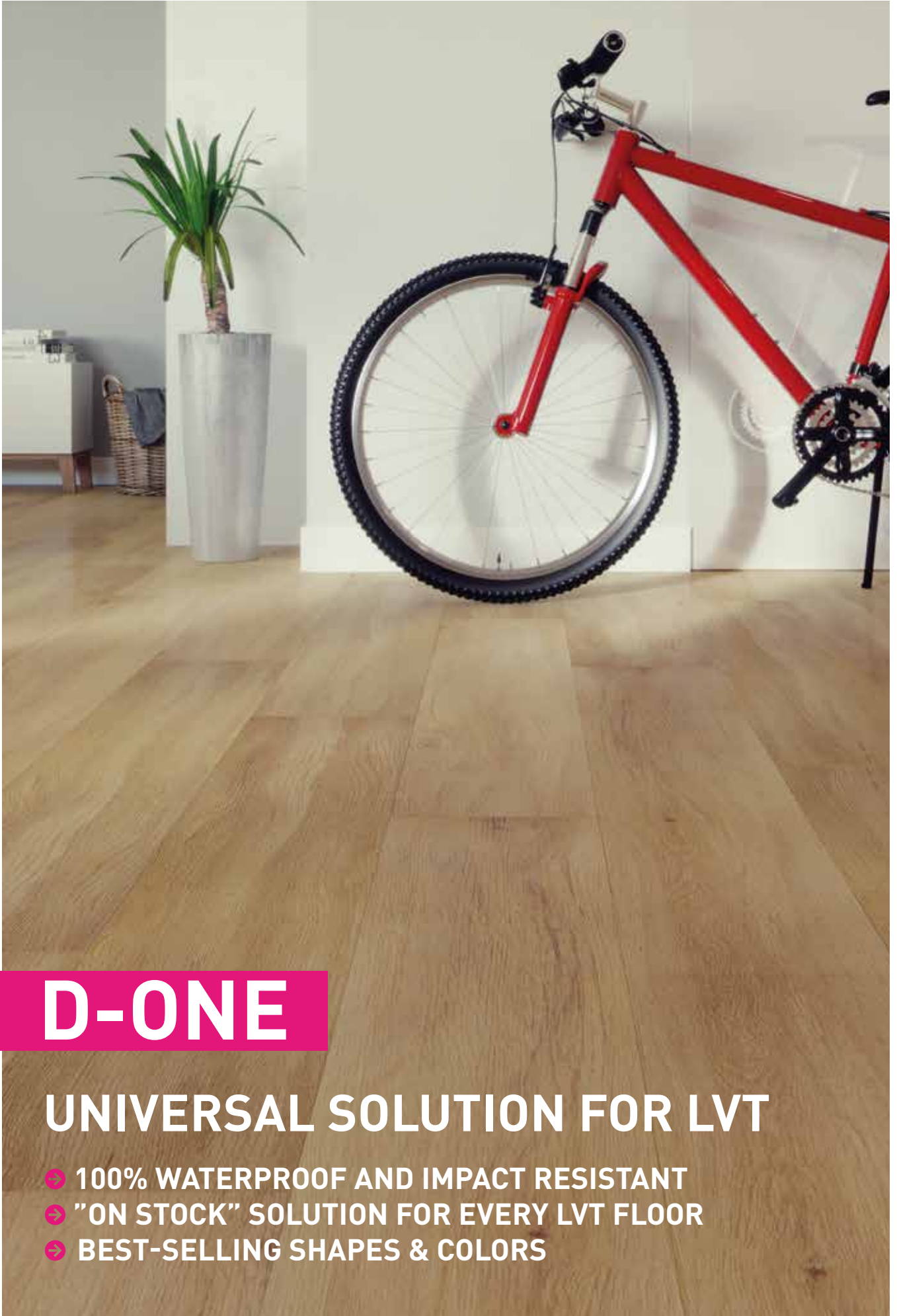

D-ONE

UNIVERSAL SOLUTION FOR LVT

- 100% WATERPROOF AND IMPACT RESISTANT
- "ON STOCK" SOLUTION FOR EVERY LVT FLOOR
- BEST-SELLING SHAPES & COLORS

D-ONE

NEW



PERFECT FOR

LVT

➔ WATERPROOF

Clean your floor without any risk
– non-deforming, water resistant board!

➔ IMPACT RESISTANT

Highest resistance and stability

➔ ALWAYS CLEAN SURFACE

Extremely smooth surface without micropores
is a perfect barrier for dirt and dust

➔ CLICK OR GLUE

Install the skirting in two ways: glue skirting directly
to the wall, or clip - strip easily and remove at any time.





D-ONE is 100% waterproof and impact resistant but also has extremely smooth surface without micropores. It is a perfect solution, easy to clean. Say no to dirt and dust.

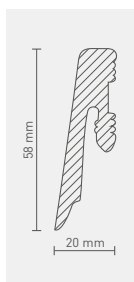

D-ONE D0610 01 white
SKIRTING 5905167805961
📏 2,4 m 📦 24 m 📦 840 m

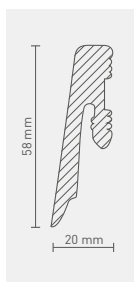

D-ONE D0610 02 inox
SKIRTING 5905167805978
📏 2,4 m 📦 24 m 📦 840 m

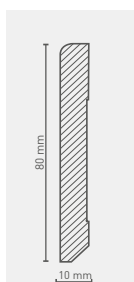

D-ONE L0810 01 white
SKIRTING 5905167806005
📏 2,4 m 📦 24 m 📦 1512 m

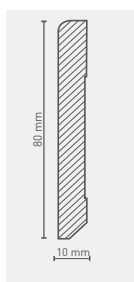

D-ONE L0810 02 inox
SKIRTING 5905167799932
📏 2,4 m 📦 24 m 📦 1512 m

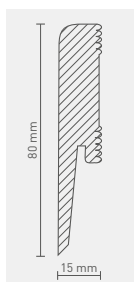

D-ONE D0810 01 white
SKIRTING 5905167805992
📏 2,4 m 📦 28,8 m 📦 604,8 m

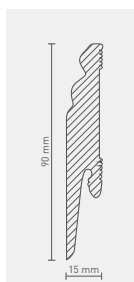

D-ONE D0910 01 white
SKIRTING 5905167805985
📏 2,4 m 📦 28,8 m 📦 604,8 m

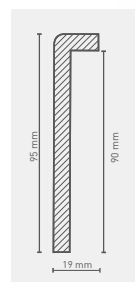

D-ONE L0950 01 white
SKIRTING 5905167806012
📏 2,4 m 📦 24 m 📦 1176 m

➔ 6 UNIVERSAL SKIRTINGS FOR LVT.

IT'S DIY FRIENDLY AND CAN BE INSTALLED WITH NO EFFORT.



➔ INSTALATION



STEP 1



STEP 2



STEP 1



STEP 2



➔ LOGISTIC DATA

	SKIRTING	BLOCKS	CLIPS AND DOWELS	STRONGMAN GLUE	ACRYLIC
	240 cm	2,3x2,3x15,2 cm	ø 6 mm	-	-
	-	4 pcs = 1 set	20 pcs	1 pcs	1 pcs
	28,8 m / 24 m	10 sets	1200 pcs	12 pcs	12 pcs

EAN	see page 12	5905167746844	5905167766651	5905167788264	5907584890193
------------	-------------	---------------	---------------	---------------	---------------

WHITE DESIGN FOR ALL FLOOR COVERINGS

IF YOU ARE LOOKING FOR
A UNIVERSAL AND MODERN
SOLUTION, CHOOSE WHITE
SKIRTING BOARDS, WHICH
CAN BE PAINTED
IN ANY COLOUR

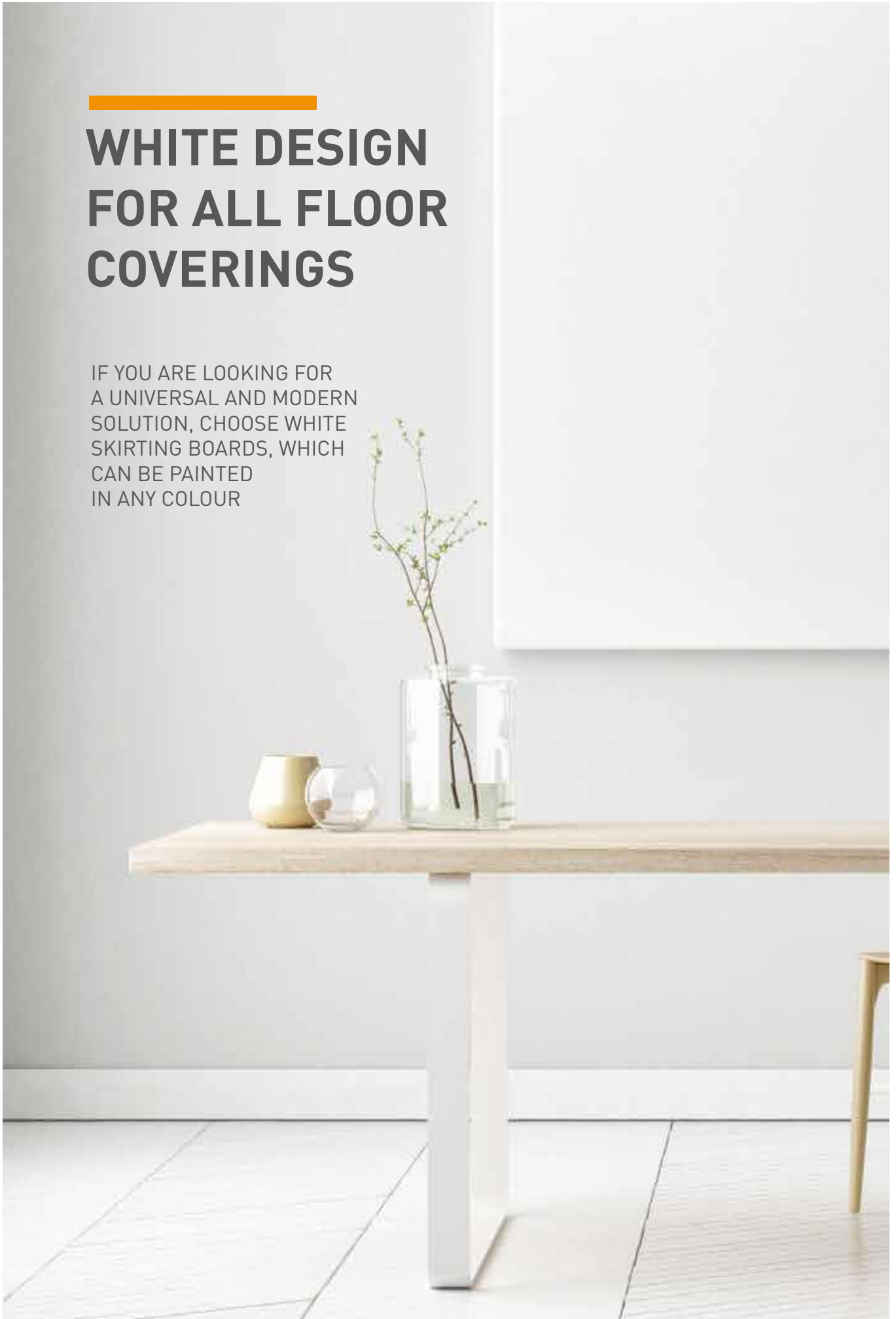

VEGA

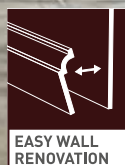

➤ WATERPROOF

Clean your floor without any risk
– non-deforming, water resistant board!

➤ 4 WAY SYSTEM

Solid, fast, simple installation and deinstalation,
for any type of wall

➤ EASY WALL RENOVATION

Possibility installation of unfixing skirtings in order
to paint or hide TV or audio cable (max 230V)

➤ KEEP IT WHITE OR PAINT IT

The board which can be painted. Possibility of fully
matching the board colours to the walls of the room

➤ IMPACT RESISTANT

Highest resistance and stability

➤ VIDELIT ECO FRIENDLY

The board made of environmentally
friendly material

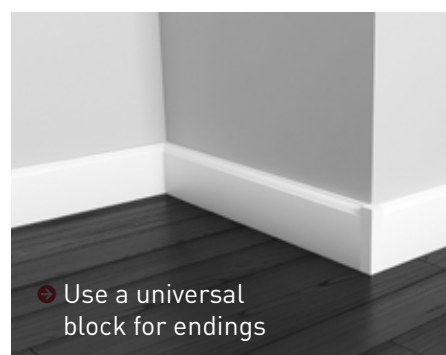



➔ INSTALATION



➔ Dowel

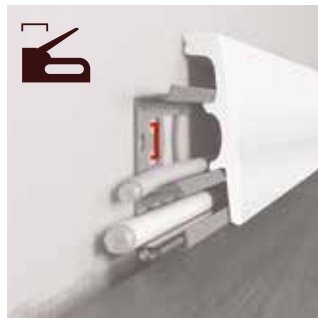

➔ Brackets

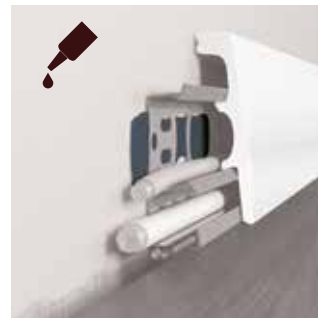

➔ Glue

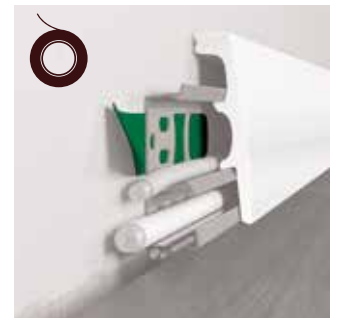







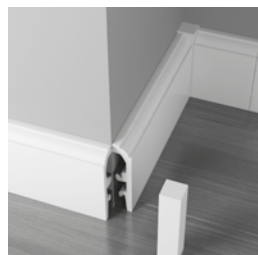
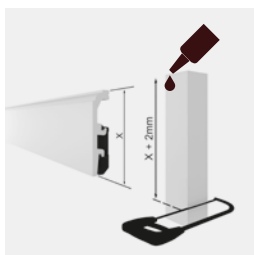
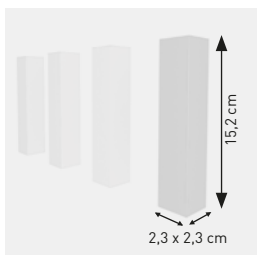

➔ Tape

➔ ACCESORIES

UNIVERSAL BLOCK



 60 mm 20 mm	 P0610 60x20 mm SKIRTING 5905167747926 2,4 m 24 m 672 m	 60 mm 20 mm	 P0620 60x20 mm SKIRTING 5905167755662 2,4 m 21,8 m 672 m	 80 mm 20 mm	 P0810 80x20 mm SKIRTING 5905167734551 2,4 m 24 m 504 m
 80 mm 20 mm	 P0811 80x20 mm SKIRTING 5905167734568 2,4 m 24 m 504 m	 80 mm 20 mm	 P0830 80x20 mm SKIRTING 5905167755679 2,4 m 24 m 504 m	 90 mm 20 mm	 P0910 90x20 mm SKIRTING 5905167734605 2,4 m 24 m 504 m
 90 mm 20 mm	 P0911 90x20 mm SKIRTING 5905167734612 2,4 m 24 m 504 m	 100 mm 20 mm	 P1010 100x20 mm SKIRTING 5905167734629 2,4 m 24 m 504 m	 100 mm 20 mm	 P1020 100x20 mm SKIRTING 5905167734643 2,4 m 24 m 504 m
 100 mm 20 mm	 P1030 100x20 mm SKIRTING 5905167755686 2,4 m 24 m 504 m				

			 NEW			
	SKIRTING	BLOCKS	STRONGMAN GLUE	TAPE	SCREW AND DOWELS	ACRYLIC
	240 cm	2,3x2,3x15,2 cm	-	-	ø 6 mm	-
	-	4 pcs = 1 set	1 pcs	1 pcs	50 pcs	1 pcs
	24 m / 28 m	10 sets	12 pcs	24 pcs	3000 pcs	12 pcs
EAN	see page 17	5905167746844	5905167788264	5905167731444	5905167748169	5907584890193

DORA



➤ WATERPROOF

Clean your floor without any risk
– non-deforming, water resistant board!

➤ IMPACT RESISTANT

Highest resistance and stability

➤ CLICK OR GLUE

Instal the skirting in two ways: glue skirting directly to the wall, or clip - strip easily and remove at any time.

➤ EASY WALL RENOVATION

Possibility of unfixing skirtings in order to paint or hide TV or audio cable (max 230V)

➤ KEEP IT WHITE OR PAINT IT

The board which can be painted.
Possibility of fully matching the board colours to the walls of the room

➤ VIDELIT ECO FRIENDLY

The board made of environmentally friendly material





↻ INSTALATION

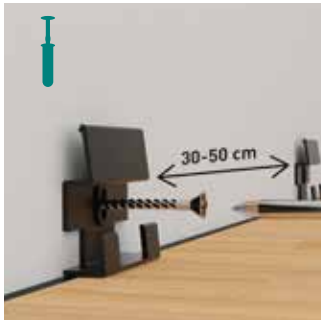

STEP 1



STEP 2



STEP 1



STEP 2

↻ ACCESORIES

UNIVERSAL BLOCK

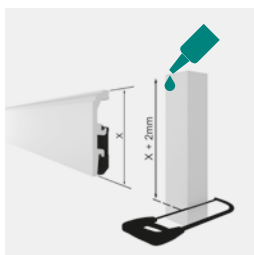
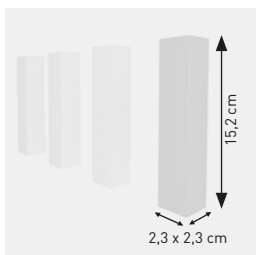

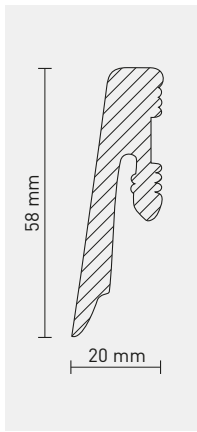

D0610 58x20 mm
 SKIRTING 5905167766491
 2,4 m 24 m 840 m

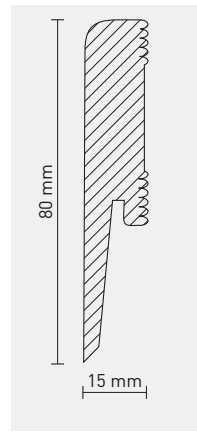

D0810 80x15 mm
 SKIRTING 5905167766507
 2,4 m 28,8 m 604,8 m

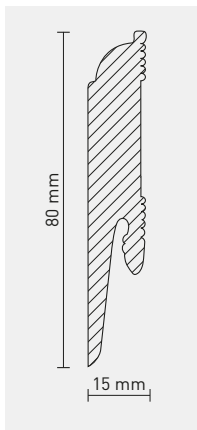

D0820 80x15 mm
 SKIRTING 5905167766514
 2,4 m 28,8 m 604,8 m

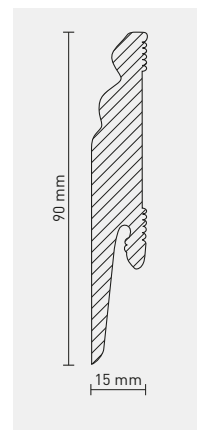

D0910 90x15 mm
 SKIRTING 5905167766521
 2,4 m 28,8 m 604,8 m

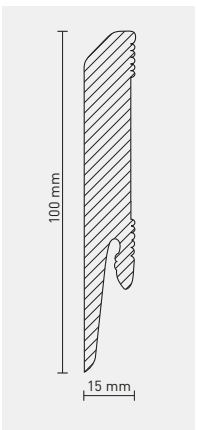

D1010 100x15 mm
 SKIRTING 5905167766538
 2,4 m 28,8 m 604,8 m

➔ LOGISTIC DATA

	SKIRTING	BLOCKS	CLIPS AND DOWELS	STRONGMAN GLUE	ACRYLIC
	240 cm	2,3x2,3x15,2 cm	ø 6 mm	-	-
	-	4 pcs = 1 set	20 pcs	1 pcs	1 pcs
	28,8 m / 24,0 m	10 sets	1200 pcs	12 pcs	12 pcs
EAN	see page 20	5905167746844	5905167766651	5905167788264	5907584890193

PAINT-IT



➔ KEEP IT WHITE OR PAINT IT

The board which can be painted.
Possibility of fully matching the board colours to the walls of the room

➔ EASY WALL RENOVATION

Possibility installation of unfixing skirtings in order to paint or hide TV or audio cable (max 230V)

➔ CLICK OR GLUE

Instal the skirting in two ways: glue skirting directly to the wall, or clip - strip easily and remove at any time.

➔ MDF

Skirting board made from MDF covered with coated paper which increases durability. It's not necessary to paint the skirting board before the first installation





Use water-based, abrasion resistant paint, including: acrylic, latex and silicone paints (do not use solvent-based paint)



➔ INSTALATION

Super strong improved mounting



STEP 1



STEP 2



STEP 3



STEP 4

NEW
Strongman Glue



STEP 1



STEP 2

MP0601 SKIRTING	60x15 mm 5905167674338	MP0602 SKIRTING	60x15 mm 5905167754986	MP0801 SKIRTING	80x15 mm 5905167674345
	2,42 m		24,2 m		1161,6 m
	2,42 m		24,2 m		847 m
MP0802 SKIRTING	80x15 mm 5905167674352	MP0901 SKIRTING	90x15 mm 5905167674369	MP1001 SKIRTING	100x15 mm 5905167674376
	2,42 m		24,2 m		847 m
	24,2 m		847 m		847 m
MP1002 SKIRTING	100x15 mm 5905167674383	MP1003 SKIRTING	100x15 mm 5905167674390	MP1004 SKIRTING	100x15 mm 5905167674406
	2,42 m		24,2 m		847 m
	24,2 m		847 m		847 m
MP1005 SKIRTING	100x15 mm 5905167674413	MP1101 SKIRTING	110x15 mm 5905167674420		
	2,42 m		24,2 m		
	24,2 m		847 m		

LOGISTIC DATA

	SKIRTING	BLOCKS	CLIPS AND DOWELS	STRONGMAN GLUE	ACRYLIC
	242 cm	1,8x1,8x11,2 cm	ø 6 mm	-	-
	-	4 pcs = 1 set	25 pcs	1 pcs	1 pcs
	24,2 m	10 sets	1500 pcs	12 pcs	12 pcs
EAN	5905167736937	5905167674437	5905167788264	5907584890193	

DIAMOND



➔ GLOSSY SURFACE

Lacquered skirting board

➔ Easy Wall RENOVATION

possibility installation of unfixing skirtings in order to paint or hide TV or audio cable (max 230V)

➔ CLICK OR GLUE

Install the skirting in two ways: glue skirting directly to the wall, or clip - strip easily and remove at any time.

➔ MDF

Skirting board made from MDF with a lacquer layer which provides additional protection from damages





Glossy skirting boards perfectly match, minimalistic and modern classic style. Additionally, they are very functional and antistatic.

➔ INSTALATION

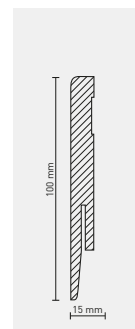
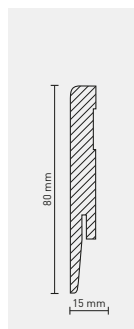
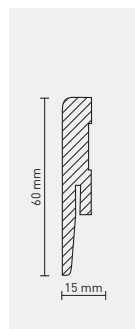
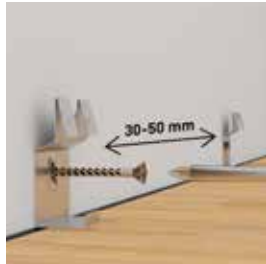

➔ LOGISTIC DATA

	SKIRTING	BLOCKS	CLIPS AND DOWELS	STRONGMAN GLUE	ACRYLIC
	242 cm	1,8x1,8x11,2 cm	ø 6 mm	-	-
	-	4 pcs = 1 set	25 pcs	1 pcs	1 pcs
	24,2 m	10 sets	1500 pcs	12 pcs	12 pcs
EAN	5905167736937	5905167674437	5905167788264	5907584890193	

WOOD DESIGN FOR ALL FLOOR COVERINGS

IF YOU WANT TO MATCH
THE COLOUR OF THE
SKIRTING BOARD WITH
THE FLOOR CHOOSE
IDEAL NATURAL WOOD
STRUCTURE RESEMBLANCE.



INTEGRA



➤ WATERPROOF

Clean your floor without any risk
– non-deforming, water resistant board!

➤ 4 WAY SYSTEM

Solid, fast, simple installation and deinstallation,
for any type of wall

➤ WOOD STRUCTURE

Structure embossed on the strip, perfectly imitating the real wood

➤ IMPACT RESISTANT

Highest resistance and stability

➤ WOOD EFFECT

The ideal colour and design match, 100% accurate
representation of wooden colors

➤ EASY WALL RENOVATION

Possibility of unfixing skirtings in order to paint or hide TV
or audio cable (max 230V)

➤ VIDELIT ECO FRIENDLY

The board made of environmentally friendly material

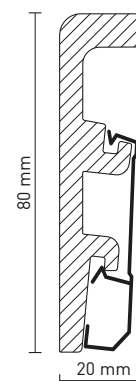
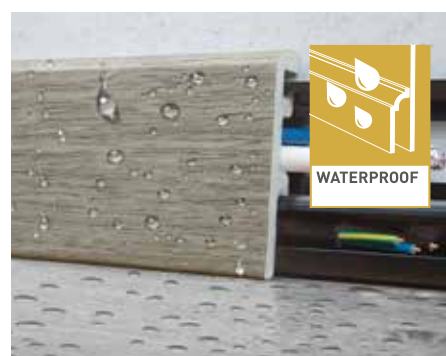



➤ **INSTALATION** EASY INSTALATION WITH DIFFERENT METHODS



Dowel

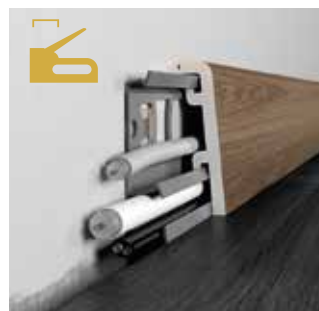

Brackets



Glue



Tape



1 | White

EAN SKIRTING 5905167734353



3 | Snow Ash

EAN SKIRTING 5905167734377



4 | Northern Ash

EAN SKIRTING 5905167734384



7 | Alabama Oak

EAN SKIRTING 5905167734414



5 | City Oak

EAN SKIRTING 5905167734391



6 | Alaska Ash

EAN SKIRTING 5905167734407



11 | Persian Oak

EAN SKIRTING 5905167734452



17 | Dark Walnut

EAN SKIRTING 5905167734513



13 | Monthana Oak

EAN SKIRTING 5905167734476



16 | Light Walnut

EAN SKIRTING 5905167734506



9 | Classic Oak

EAN SKIRTING 5905167734438



8 | Nevada Oak

EAN SKIRTING 5905167734421



10 | Calvados Oak

EAN SKIRTING 5905167734445



19 | Natural Oak

EAN SKIRTING 5905167734537



18 | Loft Oak

EAN SKIRTING 5905167734520



20 | Borneo Oak

EAN SKIRTING 5905167734544



15 | Old Oak

EAN SKIRTING 5905167734490



14 | Oregon Oak

EAN SKIRTING 5905167734483



12 | Roma Oak

EAN SKIRTING 5905167734469



2 | Aluminium

EAN SKIRTING 5905167734360

LOGISTIC DATA

	SKIRTING	STRONGMAN GLUE	TAPE	SCREW AND DOWELS
	240 cm	-	-	ø 6 mm
	-	1 pcs	1 pcs	50 pcs
	24 m	12 pcs	24 pcs	3000 pcs
	504 m	5905167788264	5905167731444	5905167748169

FADO

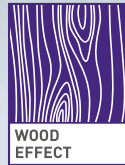

➤ WATERPROOF

Clean your floor without any risk
– non-deforming, water resistant board!

➤ IMPACT RESISTANT

Highest resistance and stability

➤ WOOD STRUCTURE

Structure embossed on the strip,
perfectly imitating the real wood

➤ WOOD EFFECT

The ideal colour and design match, 100% accurate
representation of wooden colors

➤ EASY WALL RENOVATION

Possibility installation of unfixing skirtings in order
to paint or hide TV or audio cable(max 230V)

➤ VIDELIT ECO FRIENDLY

The board made of environmentally
friendly material

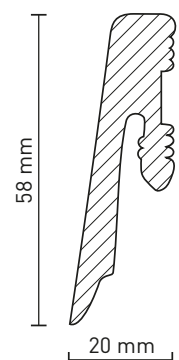



Fado skirting board is perfect for LVT floors as well as for waterproof laminate floors. Is 100% waterproof. COEX layer is a perfect barrier for dirt and water. Skirting board stays good looking for years.



coex

➔ **INSTALATION**



Super strong improved mounting



STEP 1



STEP 2



STEP 3



STEP 4



Strongman Glue



STEP 1



STEP 2



25 | Snow Oak
SKIRTING 5905167770023



19 | Ontario Oak
SKIRTING 5905167769973



26 | Buffalo Oak
SKIRTING 5905167770030



16 | Oak Caucasian
SKIRTING 5905167769966



27 | Boston Oak
SKIRTING 5905167770047



28 | Koga Oak
SKIRTING 5905167770054



30 | Davos Oak
SKIRTING 5905167770078



20 | Burgos Oak
SKIRTING 5905167769980



4 | Oak Lingburg
SKIRTING 5905167769904



22 | Valencia Oak
SKIRTING 5905167769997



29 | Santana Oak
SKIRTING 5905167770061



9 | Manorial Oak
SKIRTING 5905167769911



31 | Odessa Oak
SKIRTING 5905167770085



32 | Nebraska Oak
SKIRTING 5905167770092



11 | Holm Oak
SKIRTING 5905167769928



12 | Dark Oak
SKIRTING 5905167769935



13 | Walnut Rubra
SKIRTING 5905167769942



14 | Wenge Africa
SKIRTING 5905167769959











23 | Modena Oak
SKIRTING 5905167770009



38 | Kioto Oak
SKIRTING 5905167770016

LOGISTIC DATA

									
	SKIRTING	SCREW AND DOWELS	GLUE DF	STRONGMAN GLUE	ACCESSORIES				
	240 cm	∅ 6 mm	-	-					
	-	20 pcs	1 pcs	1 pcs	2 pcs / 25 pack	2 pcs / 25 pack	2 pcs / 25 pack	1L+1R / 25L+25R	1L+1R / 25L+25R
	24 m	1200 cm	12 pcs	12 pcs	30 pcs / 1440 pcs	30 pcs / 360 pcs	30 pcs / 360 pcs	30 pcs / 1440 pcs	30 pcs / 1440 pcs
	504 m								
		5905167766651	5907584890186	5905167788264					

INDO



- **WOOD STRUCTURE**
Structure embossed on the strip, perfectly imitating the real wood
- **4 WAY SYSTEM**
Solid, fast, simple installation and deinstallation, for any type of wall
- **WOOD EFFECT**
The ideal colour and design match, 100% accurate representation of wooden colors
- **FLEXIBLE**
Flexible adaptation to uneven walls
- **EASY WALL RENOVATION**
Possibility of unfixing skirtings in order to paint or hide TV or audio cable (max 230V)
- **ECO FRIENDLY**
The board made of environmentally friendly material

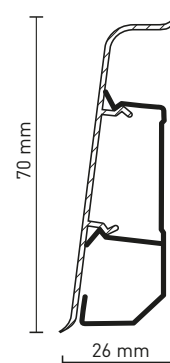
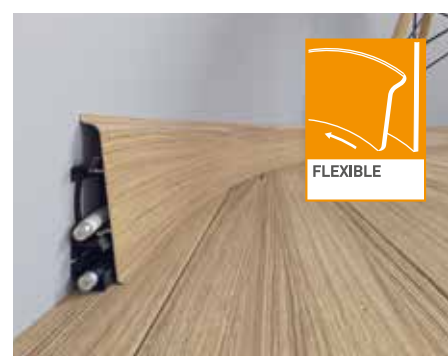

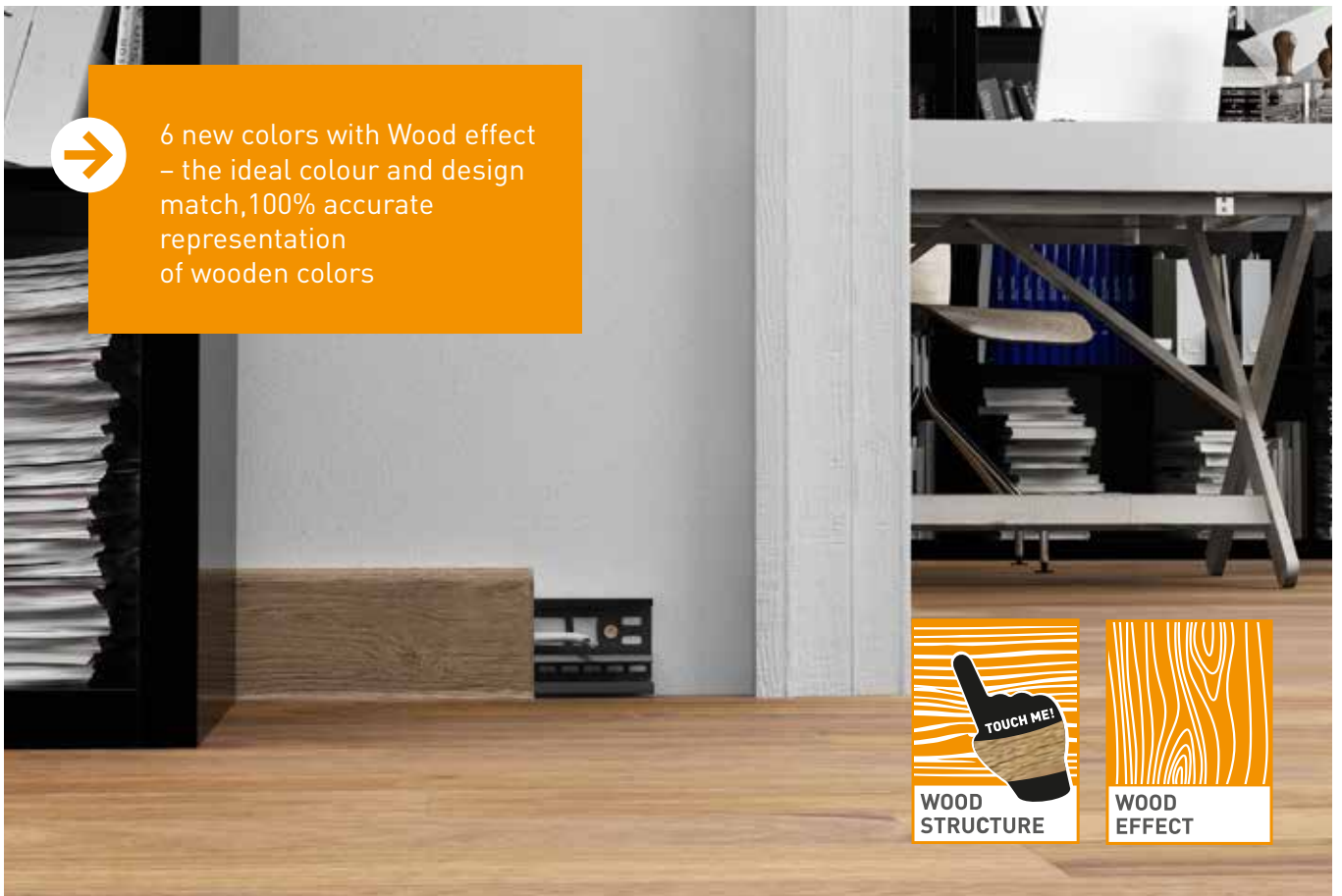

➤ INSTALATION



STEP 1



STEP 2



STEP 1



STEP 2

➤ ACCESORIES





44 | Bolton Oak

SKIRTING

5905167799000



135 | Platinum Oak

SKIRTING

5905167806067



103 | Havana Oak

SKIRTING

5905167806050



131 | Filadelfia Oak

SKIRTING

5905167806043



133 | Oxford

SKIRTING

5905167806029



134 | Cambridge

SKIRTING

5905167806036



01 | White

SKIRTING

5905167755006



40 | White Mat

SKIRTING

5905167781685



25 | Girona Chestnut

SKIRTING

5905167781326



02 | Northern Ash

SKIRTING

5905167725726

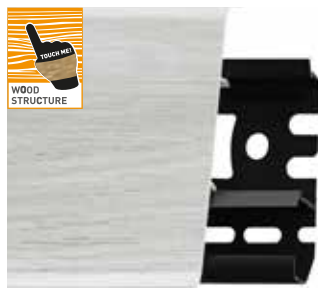

19 | Ontario Oak

SKIRTING

5905167755006



03 | Loft Oak

SKIRTING

5905167725733



20 | Burgos Oak

SKIRTING

5905167755013



42 | Sand Oak

SKIRTING

5905167781692



04 | Oak Lingburg

SKIRTING

5905167725740



07 | Liberty Oak

SKIRTING

5905167725771



05 | Windston Oak

SKIRTING

5905167725757



09 | Manorial Oak

SKIRTING

5905167725795



06 | Laplant Oak
SKIRTING 5905167725764



10 | Bourbon Oak
SKIRTING 5905167725801



29 | Lutea Oak
SKIRTING 5905167781661



12 | Dark Oak
SKIRTING 5905167725825



11 | Holm Oak
SKIRTING 5905167725818



43 | Victoria Oak
SKIRTING 5905167781333



13 | Walnut Rubra
SKIRTING 5905167725832



14 | Wenge Africa
SKIRTING 5905167725849



16 | Oak Caucasian
SKIRTING 5905167725863



23 | Valencia Oak
SKIRTING 5905167755044



41 | Aluminium light
SKIRTING 5905167781340

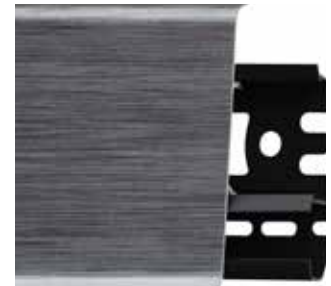

17 | Aluminium
SKIRTING 5905167729281



18 | Glossy black
SKIRTING 5905167729304

LOGISTIC DATA

	SKIRTING	MULTIBOX	STRONGMAN GLUE	TAPE	SCREW AND DOWELS	ACCESSORIES				
250 cm	-	-	-	-	ø 6 mm	-	-	-	-	-
	-	1 pcs	1 pcs	1 pcs	50 pcs	$\frac{2 \text{ psc}}{25 \text{ pack}}$	$\frac{2 \text{ psc}}{25 \text{ pack}}$	$\frac{2 \text{ psc}}{25 \text{ pack}}$	$\frac{1L+1R}{25L+25R}$	$\frac{1L+1R}{25L+25R}$
25 m	10 pcs	12 pcs	24 pcs	3000 pcs		$\frac{30 \text{ psc}}{1440 \text{ pcs}}$	$\frac{30 \text{ psc}}{360 \text{ pcs}}$	$\frac{30 \text{ psc}}{360 \text{ pcs}}$	$\frac{30 \text{ psc}}{1440 \text{ pcs}}$	$\frac{30 \text{ psc}}{1440 \text{ pcs}}$
875 m	5905167729267	5905167788264	5905167731444	5905167748169						

LARS

MODERN DESIGN



➤ WOOD STRUCTURE

Structure embossed on the strip, perfectly imitating the real wood

➤ EASY INSTALLATION

Wide installation channel provides an easy access for a drill or screwdriver. It makes installation quicker and easier

➤ FLEXIBLE

Flexible adaptation to uneven walls

➤ MODERN DESIGN

Unique shape was created for a modern interiors and its simplicity is an answer even for the most demanding

➤ PB ECO FRIENDLY

The board made of environmentally friendly material

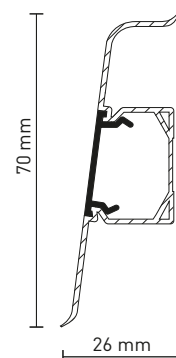



Wood structure technology is a structure embossed on the strip, perfectly imitating the real wood Wood effect – the ideal colour and design match, 100% accurate representation of wooden colors



➤ **INSTALLATION**



STEP 1



STEP 2



STEP 3



STEP 4

➤ **ACCESORIES**





40 | White Mat
SKIRTING 5905167783504

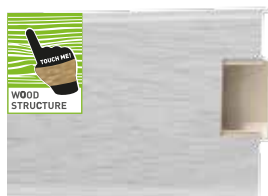

25 | Snow Ash
SKIRTING 5905167783474



44 | Platinum Oak
SKIRTING 5905167783535



02 | Winterwood Ash
SKIRTING 5905167783399



50 | Scandinavian Oak
SKIRTING 5905167783580



16 | Holm Oak
SKIRTING 5905167783429



03 | Norwegian Oak
SKIRTING 5905167783412



42 | Arena Oak
SKIRTING 5905167783511



04 | Alpine Oak
SKIRTING 5905167783443



45 | Swedish Oak
SKIRTING 905167783528



46 | Golden Oak
SKIRTING 5905167783559



09 | Noble Oak
SKIRTING 5905167783436



47 | Tatra Oak
SKIRTING 5905167783542



48 | Old Oak
SKIRTING 5905167783566



32 | Elegant Oak
SKIRTING 5905167783498



49 | Walnut Leopard
SKIRTING 5905167783573



12 | Brazilian Walnut
SKIRTING 5905167783450



14 | Wood Wenge
SKIRTING 5905167783405

➔ LOGISTIC DATA

	SKIRTING	MULTIBOX	STRONGMAN GLUE NEW	TAPE	SCREW AND DOWELS	ACCESSORIES				
250 cm	-	-	-	-	ø 6 mm	-	-	-	-	-
	-	1 pcs	1 pcs	1 pcs	50 pcs	2 psc / 25 pack	2 psc / 25 pack	2 psc / 25 pack	1L+1R / 25L+25R	1L+1R / 25L+25R
50 m	10 pcs	12 pcs	24 pcs	3000 pcs		30 psc / 1440 pcs	30 psc / 360 pcs	30 psc / 360 pcs	30 psc / 1440 pcs	30 psc / 1440 pcs
1750 m	5905167729267	5905167788264	5905167731444	5905167748169						

MACK

NEW



MODERN DESIGN



EASY INSTALLATION



FLEXIBLE



➔ MODERN DESIGN

Unique shape was created for a modern interiors and its simplicity is an answer even for the most demanding

➔ EASY INSTALLATION

Wide installation channel provides an easy access for a drill or screwdriver. It makes installation quicker and easier

➔ FLEXIBLE

Flexible adaptation to uneven walls

➔ PB ECO FRIENDLY

The board made of environmentally friendly material

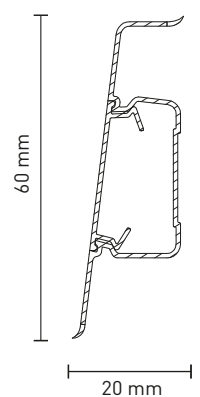



➤ **INSTALATION**



STEP 1



STEP 2



STEP 3



STEP 4

➤ **ACCESORIES**





40 | White Matt

SKIRTING 5905167803554



130 | Canberra Oak

SKIRTING 5905167803561



25 | Girona Chestnut

SKIRTING 5905167803578



107 | Bolton Oak

SKIRTING 5905167803585



02 | North Ash

SKIRTING 5905167803592



135 | Platinum Oak

SKIRTING 5905167803615

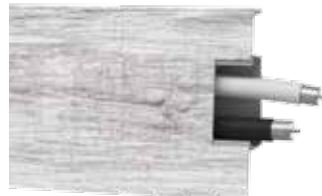

131 | Philadelphia Oak

SKIRTING 5905167803622



16 | Caucasian Oak

SKIRTING 5905167803639



42 | Arena Oak

SKIRTING 5905167803646



03 | Loft Oak

SKIRTING 5905167803653



04 | Lingburg Oak

SKIRTING 5905167803660



136 | Antiqe Oak

SKIRTING 5905167803677



86 | Laplant Oak

SKIRTING 5905167803684



132 | Edmonton Oak

SKIRTING 5905167803707



14 | Wood Wenge

SKIRTING 5905167803714



41 | Alu Light

SKIRTING 5905167803721

➔ LOGISTIC DATA

	 SKIRTING	 MULTIBOX	 STRONGMAN GLUE	 TAPE	 SCREW AND DOWELS	 ACCESSORIES				
 250 cm	-	-	-	-	-	ø-6 mm				
 -	1 pcs	1 pcs	1 pcs	1 pcs	50 pcs	$\frac{2 \text{ psc}}{25 \text{ pack}}$	$\frac{2 \text{ psc}}{25 \text{ pack}}$	$\frac{2 \text{ psc}}{25 \text{ pack}}$	$\frac{1L+1R}{25L+25R}$	$\frac{1L+1R}{25L+25R}$
 100 m	10 pcs	12 pcs	24 pcs	3000 pcs		$\frac{30 \text{ psc}}{1440 \text{ pcs}}$	$\frac{30 \text{ psc}}{360 \text{ pcs}}$	$\frac{30 \text{ psc}}{360 \text{ pcs}}$	$\frac{30 \text{ psc}}{1440 \text{ pcs}}$	$\frac{30 \text{ psc}}{1440 \text{ pcs}}$
 2400 m	5905167729267	5905167788264	5905167731444	5905167748169						

LM 60



➤ WOOD EFFECT

The ideal colour and design match, 100% accurate representation of wooden colors

➤ EASY WALL RENOVATION

Possibility of unfixing skirtings in order to paint or hide TV or audio cable (max 230V)

➤ FLEXIBLE

Flexible adaptation to uneven walls

➤ ECO FRIENDLY

The board made of environmentally friendly material

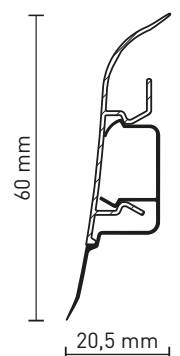



Wood effect – the ideal colour and design match, 100% accurate representation of wooden colors

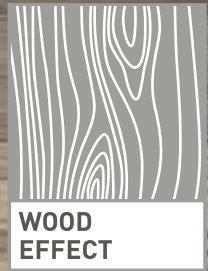

➤ INSTALATION



STEP 1



STEP 2



STEP 3



STEP 4

➤ ACCESORIES





34 | White

SKIRTING

5905167749043



107 | Bolton Oak

SKIRTING

5905167752944



44 | Golden Oak

SKIRTING

5907749020083



58 | Rural Oak

SKIRTING

5905167662946



23 | Ash

SKIRTING

5907749001891



109 | Sevilla Oak

SKIRTING

5905167753149



77 | Sand Oak

SKIRTING

5905167662953



49 | Liverpool Oak

SKIRTING

5907749020144



70 | White Oak

SKIRTING

5905167663226



16 | Antique Oak

SKIRTING

5906735694451



24 | Highland Oak

SKIRTING

5907749012064



86 | Laplant Oak

SKIRTING

5907749049282



65 | Canyon Oak

SKIRTING

5905167662656



52 | Ardennes Oak

SKIRTING

5907749020311



94 | Oak Victoria

SKIRTING

5905167703175



72 | Bourbon Oak
SKIRTING 5905167663264



63 | Tosca Oak
SKIRTING 5905167663349



74 | Rustic Oak
SKIRTING 5905167663295



97 | Lagos Oak
SKIRTING 5905167709528











99 | Kendari Oak
SKIRTING 5905167709542



39 | Aluminium
SKIRTING 5907749020014

➔ LOGISTIC DATA

	 SKIRTING	 MULTIBOX	 SCREW AND DOWELS	 ACCESSORIES 				
 250 cm	250 cm	-	∅ 6 mm	-	-	-	-	-
 -	-	1 pcs	50 pcs	$\frac{2 \text{ pcs}}{25 \text{ pack}}$	$\frac{2 \text{ pcs}}{25 \text{ pack}}$	$\frac{2 \text{ pcs}}{25 \text{ pack}}$	$\frac{1L+1R}{25L+25R}$	$\frac{1L+1R}{25L+25R}$
 50 m	50 m	10 pcs	3000 pcs	$\frac{30 \text{ pcs}}{1440 \text{ pcs}}$	$\frac{30 \text{ pcs}}{360 \text{ pcs}}$	$\frac{30 \text{ pcs}}{360 \text{ pcs}}$	$\frac{30 \text{ pcs}}{1440 \text{ pcs}}$	$\frac{30 \text{ pcs}}{1440 \text{ pcs}}$
 1750 m	1750 m	5906735698503	5905167748169					

LM 55

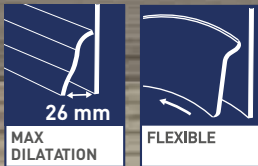

- ➔ **LARGE COVERING SURFACE – 26 MM**
- ➔ **FLEXIBLE ADAPTATION**
to uneven walls
- ➔ **ECO FRIENDLY PVC**
The board made of environmentally friendly material

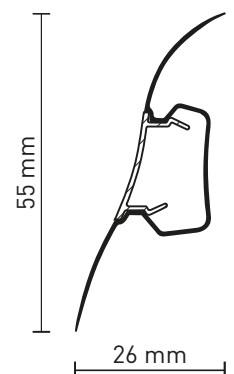



➤ **INSTALATION**



STEP 1



STEP 2



STEP 3



STEP 4

➤ **ACCESORIES**





NEW

101 | White Matt

SKIRTING 5905167735558



108 | Aspen Oak

SKIRTING 5905167788349



103 | Havana Oak

SKIRTING 5905167741153



58 | Rural Oak

SKIRTING 5905167662748



48 | Golden Oak

SKIRTING 5907749020243



107 | Girona Chestnut

SKIRTING 5905167788332



49 | Belfast Oak

SKIRTING 5907749020250



23 | Ash

SKIRTING 5907749001174



77 | Sand Oak

SKIRTING 5905167734810



110 | Ginkgo Biloba

SKIRTING 5905167788363



47 | Liverpool Oak

SKIRTING 5907749014853



109 | Ageing Oak

SKIRTING 5905167788356



104 | Sardinia Oak

SKIRTING 5905167741948



102 | Almelo Oak

SKIRTING 5905167741146



65 | Canyon Oak

SKIRTING 5905167662762



20 | Savoyen Oak
SKIRTING 5906735647785



34 | Alaska Oak
SKIRTING 5907749014716



85 | North Oak
SKIRTING 5907749049329



86 | Laplant Oak
SKIRTING 5905167670293



16 | Antique Oak
SKIRTING 5906735647747



67 | Classic Light Oak
SKIRTING 5905167662885



83 | Romantic Oak
SKIRTING 5905167662915



28 | Pecan
SKIRTING 5907749001228



26 | Dark Oak
SKIRTING 5907749001204



112 | Jupiter Walnut
SKIRTING 5905167788387











22 | Wenge Africa
SKIRTING 5907749001167



45 | Grey Acacia
SKIRTING 5907749020236

➔ LOGISTIC DATA

	 SKIRTING	 MULTIBOX	 SCREW AND DOWELS	 ACCESSORIES 				
	250 cm	-	ø 6 mm	-	-	-	-	-
	-	1 pcs	50 pcs	$\frac{2 \text{ pcs}}{25 \text{ pack}}$	$\frac{2 \text{ pcs}}{25 \text{ pack}}$	$\frac{2 \text{ pcs}}{25 \text{ pack}}$	$\frac{1L+1R}{25L+25R}$	$\frac{1L+1R}{25L+25R}$
	50 m	10 pcs	3000 pcs	$\frac{30 \text{ pcs}}{1440 \text{ pcs}}$	$\frac{30 \text{ pcs}}{360 \text{ pcs}}$	$\frac{30 \text{ pcs}}{360 \text{ pcs}}$	$\frac{30 \text{ pcs}}{1440 \text{ pcs}}$	$\frac{30 \text{ pcs}}{1440 \text{ pcs}}$
	1750 m	5906735649598	5905167748169					



**OTHERS SYSTEMS
FOR CERAMIC AND CARPET**

LATIKA

PERFECT FOR
LVT
CERAMIC



- ➔ **ALWAYS CLEAN SURFACE**
Extremely smooth surface without micropores is a perfect barrier for dirt and dust
- ➔ **WATERPROOF**
Clean your floor without any risk
– non-deforming, water resistant board!
- ➔ **IMPACT RESISTANT**
Highest resistance and stability

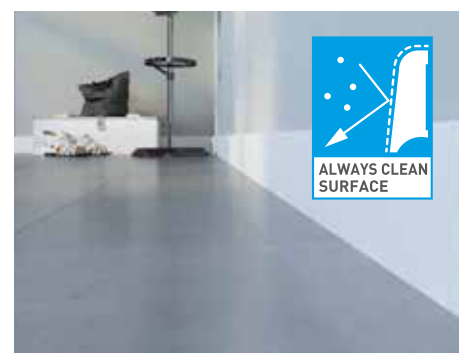



The existing tile plinths can be easily covered by Latika skirting boards



➔ INSTALATION



STEP 1



STEP 2

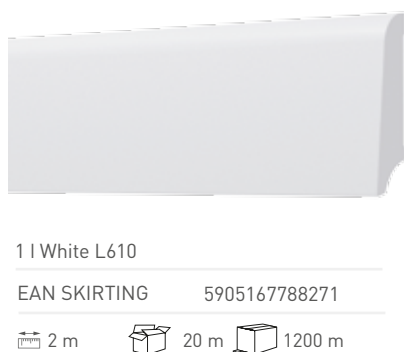
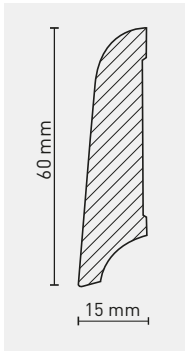

1 | White L610
 EAN SKIRTING 5905167788271
 2 m 20 m 1200 m

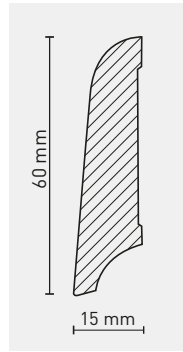

2 | Inox L610
 EAN SKIRTING 5905167788288
 2 m 20 m 1200 m

2 m
 20 m
 1920 m

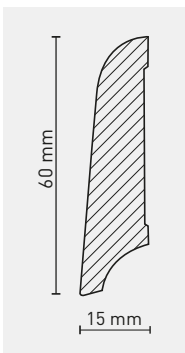

3 | Stone Grey L610
 EAN SKIRTING 5905167788295
 2 m 20 m 1200 m

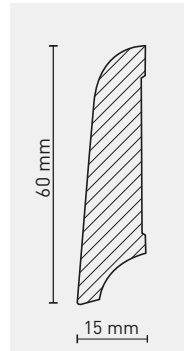

4 | Stone graphite L610
 EAN SKIRTING 5905167788301
 2 m 20 m 1200 m

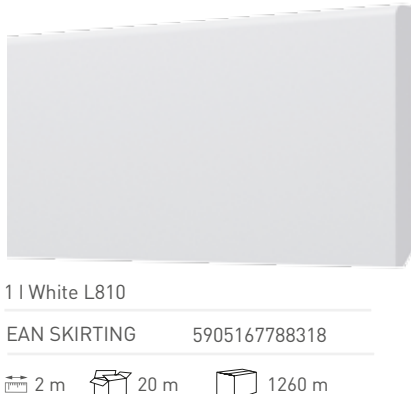
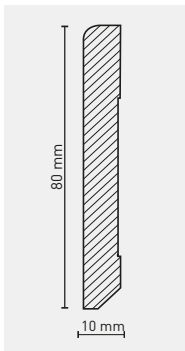

1 | White L810
 EAN SKIRTING 5905167788318
 2 m 20 m 1260 m

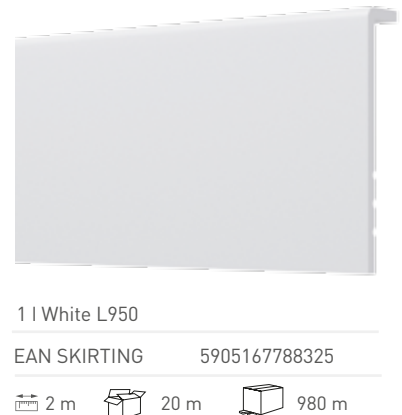
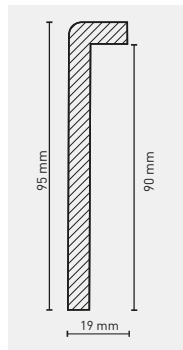

1 | White L950
 EAN SKIRTING 5905167788325
 2 m 20 m 980 m

➔ LOGISTIC DATA

	SKIRTING		STRONGMAN GLUE
	200 cm		-
	-		1 pcs
	20 m		12 pcs

5905167788264

TSL



- **Easy and fast**
flooring assembly with self-adhesive tape
- **A decorative canopy available in several colours,**
allows to match the strip to any type of flooring

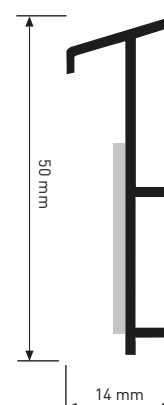
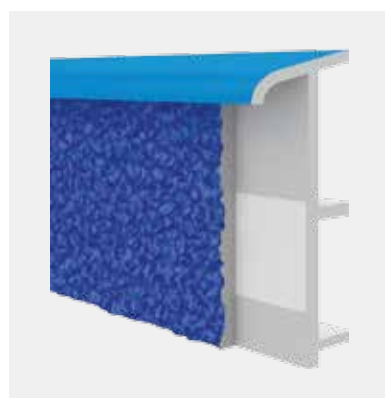

↪ INSTALLATION



STEP 1



STEP 2



STEP 3

QUICK
INSTALLATION
DIRECTLY
ON THE WALL

↪ ACCESSORIES

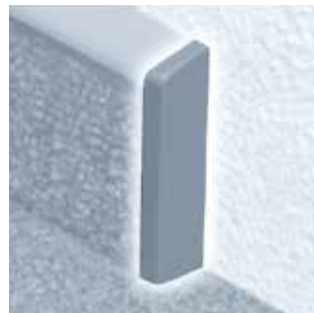
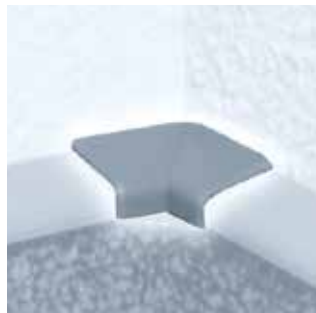
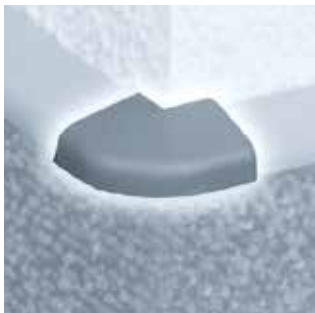

↪ COLORS

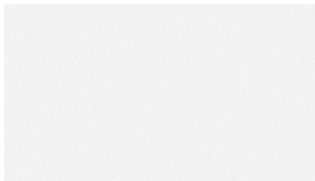

01 | White

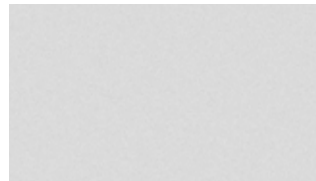

21 | Light Grey

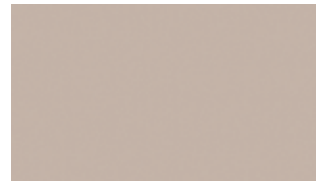

24 | Beige



25 | Light Beige



27 | Graphite











20 | Brown



26 | Light Brown



19 | Black

								
Colour	2,5 m/50 m	50 psc/600 pcs	50 psc/600 pcs	50 psc/1200 pcs	50 psc/1200 pcs	2 psc/50 pack	2 psc/50 pack	4L+4R/25L+25R
1	5907584895006	5907584895037	5907584895044	5907584895020	5907584895013	5907749043624	5907749043785	5907749043945
19	5907584895105	5907584895136	5907584895143	5907584895129	5907584895112	5907749043693	5907749043853	5907749044010
20	5907584895150	5907584895181	5907584895198	5907584895174	5907584895167	5907749043709	5907749043860	5907749044027
21	5907584895051	5907584895082	5907584895099	5907584895075	5907584895068	5907749043716	5907749043877	5907749044034
24	5906735692976	5906735692983	5906735693003	5906735693027	5906735693041	5907749043747	5907749043907	5907749044065
25	5906735693065	5906735693072	5906735693096	5906735693119	5906735693133	5907749043754	5907749043914	5907749044072
26	5906735693157	5906735693164	5906735693188	5906735693201	5906735693225	5907749043761	5907749043921	5907749044089
27	5906735693249	5906735693256	5906735693270	5906735693294	5906735693317	5907749043778	5907749043938	5907749044096



UNIVERSAL PROFILES

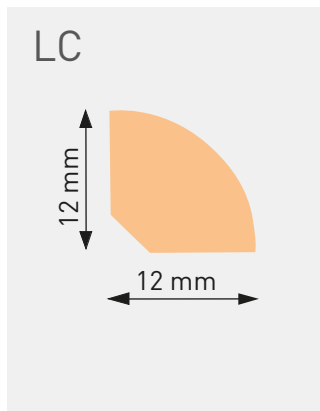

QUARTER ROUND PROFILE

LC 12 x 12 mm	
00	5907584871017
01	5907584871024
02	5907584871055
04	5907584871048
08	5907584871062
11	5907584871031
2,5 m / 50 m	

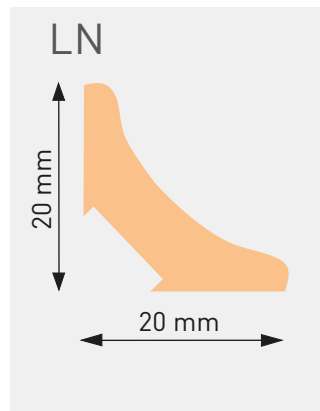

CORNER PROFILE

LN 20x20 mm	
00	5907584871109
01	5907584871116
02	5907584871147
04	5907584871130
08	5907584871154
11	5907584871123
2,5 m / 50 m	

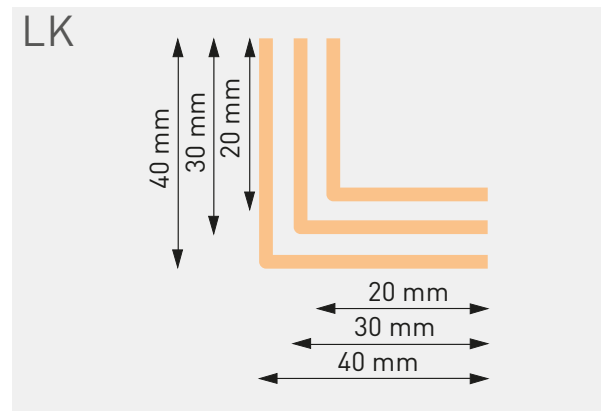

ANGLE BARS WITH BOTH SIDES PRINTED

	LK 20 x 20 mm	LK 30 x 30 mm	LK 40 x 40 mm
00	5907584871208	5907584871307	5907584871406
01	5907584871215	5907584871314	5907584871413
02	5907584871246	5907584871345	5907584871444
07	5907584871222	5907584871321	5907584871420
08	5907584871239	5907584871338	5907584871437
11	5907584871253	5907584871352	5907584871451
12	5906735622478	5906735622485	5906735622492
	2,75 m / 55 m	2,75 m / 55 m	2,75 m / 55 m



White



White



Beech



White Beech



Dark Oak



White Oak



Grey Ash



Mahogany

MARKETING MATERIALS

→ WEBSITE

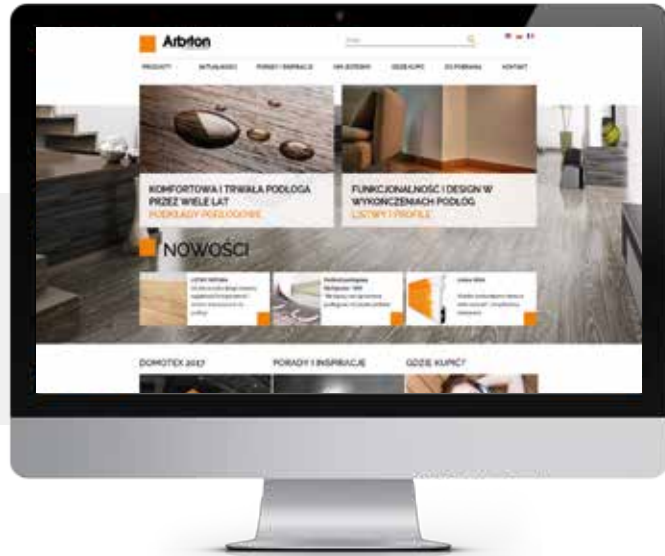

→ FOLDERS

→ POS



ACCESSORIES



→ CLIPS AND DOWEL

 /  ø 6 mm

 25 pcs  1500 pcs

EAN 5905167674437

→ CLIPS AND DOWEL

 /  ø 6 mm

 20 pcs  1200 pcs

EAN 5905167766651



→ TAPE

 /  -

 1 pcs  24 pcs

EAN 5905167731444

→ STRONGMAN GLUE

 /  -

 1 pcs  12 pcs

EAN 5905167788264



NEW



→ ACRYL



 /  -

 1 pcs  12 pcs

EAN 5907584890193

→ BLOCKS

 /  2,3x2,3x15,2 cm

 4 pcs = 1 set  10 sets

EAN 5905167746844



→ SCREWS AND DOWELS

 /  ø 6 mm

 50 pcs  3000 pcs

EAN 5905167748169

The catalogue is a free of charge presentation of products of Decora S.A. and acc. to valid law it is not a commercial offer. Colors and textures of the products in pictures may differ from real ones because of limited printing technologies. Decora S.A. reserves its right to alter availability of the products on some markets and at some distributors. The products included in the catalogues do not pose a complete offer of Decora S.A.



v.01.18